

Contents

1 - Notices	2
1.1 - Safety warnings.....	2
1.2 - General notices	2
2 - About your AIS SART	5
2.1 - About AIS	5
2.2 - What's in the box.....	6
2.3 - AIS SART overview.....	8
3 - Installation	9
3.1 - Installing the mounting bracket	9
4 - Operation	12
4.1 - Activating the AIS SART	12
4.2 - Deploying the AIS SART.....	13
4.3 - Deactivating the AIS SART	15
4.4 - Testing the AIS SART	15
4.5 - Display of AIS SART messages on other equipment.....	16
5 - Battery information	18
5.1 - Battery replacement	18
5.2 - Transport.....	18
5.3 - Disposal	18
6 - Troubleshooting.....	19
7 - Specification.....	20

1 Notices

 When reading this manual please pay attention to warnings marked with the warning triangle shown on the left. These are important messages for safety, installation and usage of the product.

1.1 Safety warnings

 This equipment must be installed and operated in accordance with the instructions provided in this manual.

 An AIS SART is an emergency beacon and should only be activated when there is imminent danger to life. Misuse could endanger other lives and may result in a penalty.

 If the AIS SART has been activated for any period the battery and activation cover must be replaced. Please contact your dealer to arrange for service and replacement of the battery and activation cover.

 Replace the battery before the expiry date shown on the AIS SART. This is essential to ensure the AIS SART will operate for the required duration in an emergency situation.

 The AIS SART contains a Lithium metal battery. Ensure that the battery is removed prior to disposal. Please refer to local regulations for the safe disposal of the AIS SART and battery. Do not incinerate, puncture, short circuit or attempt to recharge the battery.

 Do not use solvents or other chemicals to clean the AIS SART. If cleaning is required use a cloth moistened with fresh water only.

1.2 General notices

Position source

All marine Automatic Identification System (AIS) transceivers utilise a satellite based location system such as the Global Positioning System (GPS) network.

The accuracy of a GPS position fix is variable and is affected by factors such as the antenna positioning, how many satellites are used to determine a position and for how long satellite information has been received.

Compass safe distance

The compass safe distance of this unit is 0.2m or greater for 0.3° deviation.

RF emissions notice

Caution: The AIS SART generates and radiates radio frequency electromagnetic energy. This equipment must be installed and operated according to the instructions contained in this manual. Failure to do so can result in personal injury and / or malfunction of the AIS SART.

Warranty

This product is supplied with standard warranty as defined in the accompanying warranty information.



Any attempt to tamper with or damage this product will invalidate the warranty.

Disposal of this product and packaging

Please dispose of the AIS transceiver in accordance with the European WEEE Directive or with the applicable local regulations for disposal of electrical equipment.

Every effort has been made to ensure the packaging for this product is recyclable. Please dispose of the packaging in an environmentally friendly manner.

Accuracy of this manual

The AIS transceiver may be upgraded from time to time and future versions of the AIS transceiver may therefore not correspond exactly with this manual. Information contained in this manual is liable to change without notice. The manufacturer of this product disclaims any liability for consequences arising from omissions or inaccuracies in this manual and any other documentation provided with this product.

Declaration of conformity

The manufacturer of this product declares that this product is in compliance with the essential requirements and other provisions of the R&TTE directive. The declaration of conformity is provided with the product document pack.

The product carries the CE mark, notified body number and alert symbol as required by the R&TTE directive.

The product is intended for sale in the following member states: Great Britain, France, Spain, Sweden, Austria, Netherlands, Portugal, Denmark, Norway, Belgium, Italy, Finland, Ireland, Luxembourg, Germany and Czech Republic.

FCC notice

This equipment has been tested and found to comply with the limits for a class B digital device, pursuant to part 15 of the FCC Rules. These limits are designed to provide reasonable protection against harmful interference in a residential installation. This equipment generates, uses and can radiate radio frequency energy and, if not installed and used in accordance with the instructions, may cause harmful interference to radio communications.

This device complies with part 15 of the FCC Rules. Operation is subject to the following two conditions: (1) This device may not cause harmful interference, and (2) this device must accept any interference received, including interference that may cause undesired operation.

Changes or modifications not expressly approved by the party responsible for compliance could void the user's authority to operate the equipment.

 **WARNING: It is a violation of the rules of the Federal Communications Commission to input an MMSI that has not been properly assigned to the end user, or to otherwise input any inaccurate data in this device.**

Industry Canada notice

This device complies with Industry Canada licence-exempt RSS standard(s). Operation is subject to the following two conditions:

1. This device may not cause interference, and
2. This device must accept any interference, including interference that may cause undesired operation of the device.

This Class B digital apparatus complies with Canadian ICES-003.

Le présent appareil est conforme aux CNR d'Industrie Canada applicables aux appareils radio exempts de licence. L'exploitation est autorisée aux deux conditions suivantes :

1. L'appareil ne doit pas produire de brouillage, et
2. L'utilisateur de l'appareil doit accepter tout brouillage radioélectrique subi, même si le brouillage est susceptible d'en compromettre le Fonctionnement.

Cet appareil numérique de la classe B est conforme à la norme NMB-003 du Canada.

2 About your AIS SART

2.1 About AIS

The marine Automatic Identification System (AIS) is a location and vessel information reporting system. It allows vessels equipped with AIS to automatically and dynamically share and regularly update their position, speed, course and other information such as vessel identity with similarly equipped vessels. Position is derived from the Global Positioning System (GPS) and communication between vessels is by Very High Frequency (VHF) digital transmissions.

There are a number of types of AIS device as follows:

- **Class A transceivers.** These are similar to class B transceivers, but are designed to be fitted to large vessels such as cargo ships and large passenger vessels. Class A transceivers transmit at a higher VHF signal power than class B transceivers and therefore can be received by more distant vessels. They also transmit more frequently. Class A transceivers are mandatory on all vessels over 300 gross tonnes on international voyages and certain types of passenger vessels under SOLAS regulations.
- **Class B transceivers.** Similar to class A transceivers in many ways, but are normally lower cost due to the less stringent performance requirements. Class B transceivers transmit at a lower power and at a lower reporting rate than class A transceivers.
- **AIS base stations.** AIS base stations are used by Vessel Traffic Systems to monitor and control the transmissions of AIS transceivers.
- **Aids to Navigation (AtoN) transceivers.** AtoNs are transceivers mounted on buoys or other hazards to shipping which transmit details of their location to the surrounding vessels.
- **AIS receivers.** AIS receivers will generally receive transmissions from class A transceivers, class B transceivers, AtoNs, AIS base stations and AIS SARTs but do not transmit any information about the vessel on which they are installed.
- **AIS SART.** An AIS SART is an emergency transmitter intended for use on vessels and life rafts. The AIS SART acts as a 'locating device' to assist search and rescue services in locating a liferaft or vessel in distress. When activated the AIS SART regularly transmits its GPS position in a specific emergency message to all other AIS devices in the area. All AIS SART devices have a unique identifier set during manufacture and require no further configuration.

This product is an AIS SART.

2.2 What's in the box

Figure 1 shows the items included with your AIS SART purchase. The following sections give a brief overview of each item. Please ensure all items are present and if any of the items are not present contact your dealer.

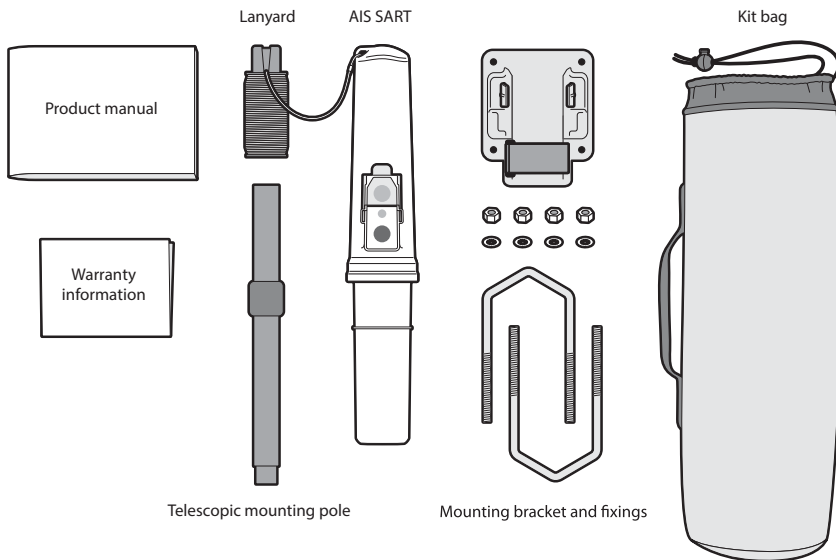

Figure 1 Items included with the product

Product manual

This document is the product manual and should be read thoroughly prior to any attempt to install or use the AIS SART.

Telescopic mounting pole

The Telescopic mounting pole can be used to mount the AIS SART 1 metre above sea level when deployed on a life raft.

Lanyard

The lanyard can be used to attach the AIS SART to the canopy of a life raft, or otherwise secure the AIS SART when deployed.

AIS SART

The main AIS SART unit.

Mounting bracket and fixings

The mounting bracket can be used when mounting the AIS SART on the bridge of a vessel or when mounting on a life boat.

Kit bag

The Kit bag can be used for storage of the AIS SART, lanyard and telescopic pole when not mounted in the bracket.

2.3 AIS SART overview

The main features of the AIS SART are identified in Figure 2.

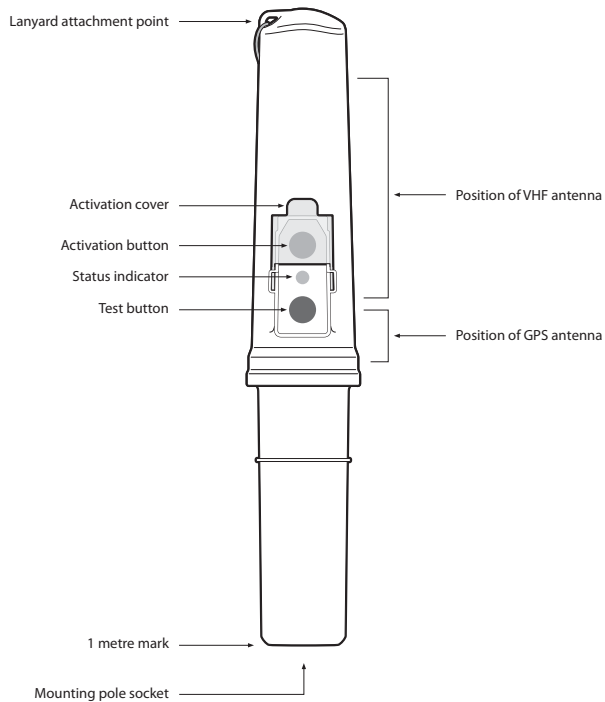

Figure 2 AIS SART overview

3 Installation

The AIS SART can be installed on a vessel or lifeboat using the supplied mounting bracket. Alternatively the AIS SART can be stored in the supplied kit bag and kept in an abandon ship bag.

The AIS SART is fully waterproof and designed for use in the marine environment, however it is recommended that the AIS SART is installed in a protected location.

3.1 Installing the mounting bracket

The mounting bracket can either be fixed to a vertical or horizontal pole using the supplied v-bolts, or fixed to a flat surface using appropriate fixings (not supplied). The supplied v-bolts are suitable for use with pipe diameter from 25mm to 50mm. The bracket should be installed in a location that can easily be reached in an emergency situation.

Figure 3 shows assembly of the AIS SART to the mounting bracket. Dimensions for the bracket mounting holes are provided in Figure 4.

To attach the AIS SART to the mounting bracket:

- Push the telescopic pole (with lanyard spool attached) into the bracket. The foam strip on the telescopic pole must align with the recess in the bracket.
- Push the AIS SART into the mounting bracket.
- Secure the AIS SART with the velcro strap.

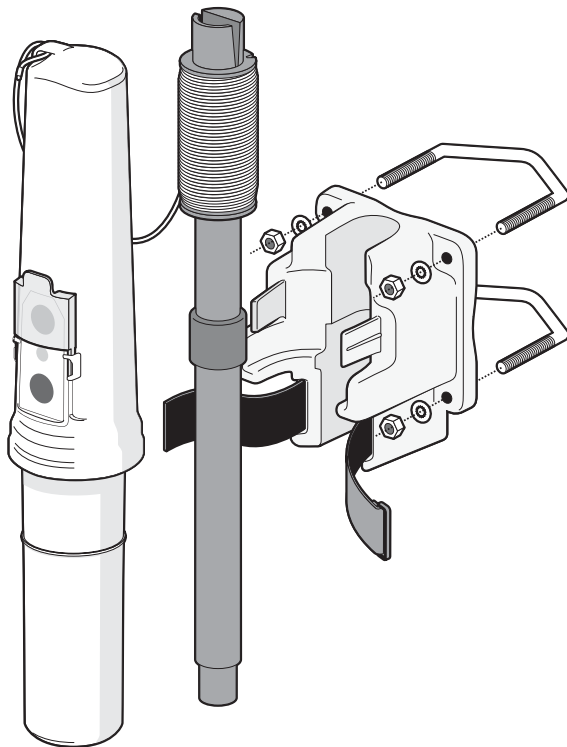

Figure 3 Attaching the AIS SART to the mounting bracket

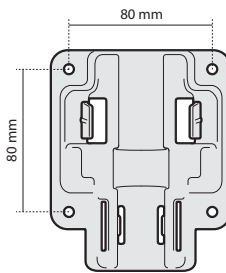

Figure 4 Dimensions for bracket mounting holes

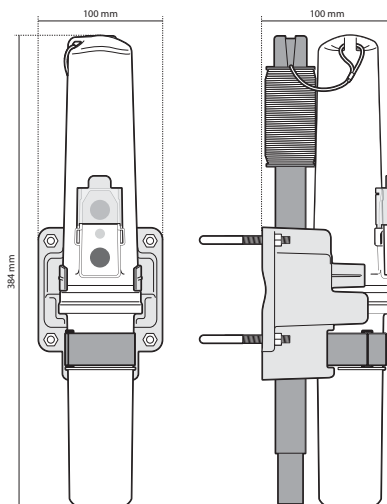

Figure 5 AIS SART overall dimensions

4 Operation



An AIS SART is an emergency beacon and should only be activated when there is imminent danger to life. Misuse could endanger other lives and may result in a penalty.

4.1 Activating the AIS SART

Activate the AIS SART before deploying it on the telescopic pole or lanyard.

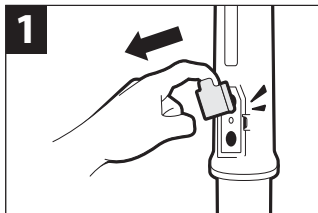

Break off activation cover

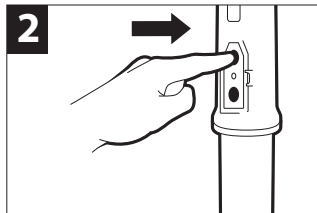

Press ON to activate

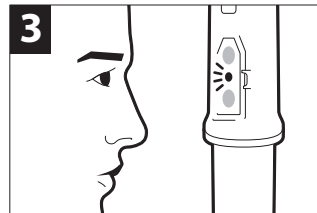

Check status indicator

Figure 6 Activation procedure

- Break off the activation cover
- Press the 'ON' button until the status LED is illuminated
- Check the status indicator according to Figure 7 to confirm operation

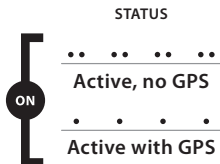

Figure 7 Status indicator in active mode

Once activated the AIS SART will operate for at least 96 hours. During operation the unique identifier and position of the AIS SART are transmitted eight times per minute and a safety text message "SART ACTIVE" is transmitted every four minutes. The status indicator shows if the AIS SART is active with or without GPS position available. Note that when initially activated it can take several minutes to obtain an initial GPS position fix. If a GPS position fix is not obtained the AIS SART should be relocated to give the GPS antenna a clear view of the sky. The location of the internal GPS antenna is shown in Figure 2.

4.2 Deploying the AIS SART

To ensure best performance the AIS SART should be mounted as high as possible on the liferaft and at least one metre above sea level. The whole body of the AIS SART should be clear of any metallic obstruction and should have a clear view of the sky. Deployment inside the canopy of an inflatable liferaft is acceptable.

The AIS SART should be activated before deploying on either the telescopic pole or lanyard.

Deploying outside the liferaft canopy

- Remove the lanyard spool from the top of the telescopic pole and tie the free end of the lanyard to a fixing point within the liferaft.
- Extend the telescopic mounting pole as indicated in Figure 8.
- Push the larger end of the telescopic mounting pole into the socket on the base of the AIS SART as indicated in Figure 9.
- Deploy the AIS SART through the SART opening in the liferaft.
- Place the lower end of the pole in the pocket provided in the liferaft.
- The base of the AIS-SART should be 1 metre above sea level when deployed as shown in Figure 10.

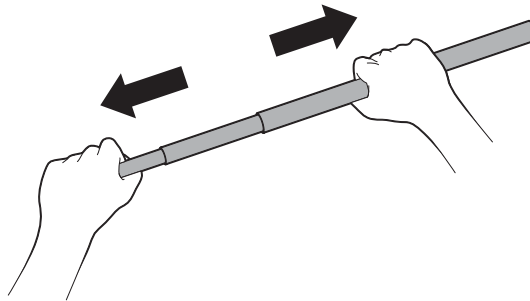

Figure 8 Extending the telescopic mounting pole

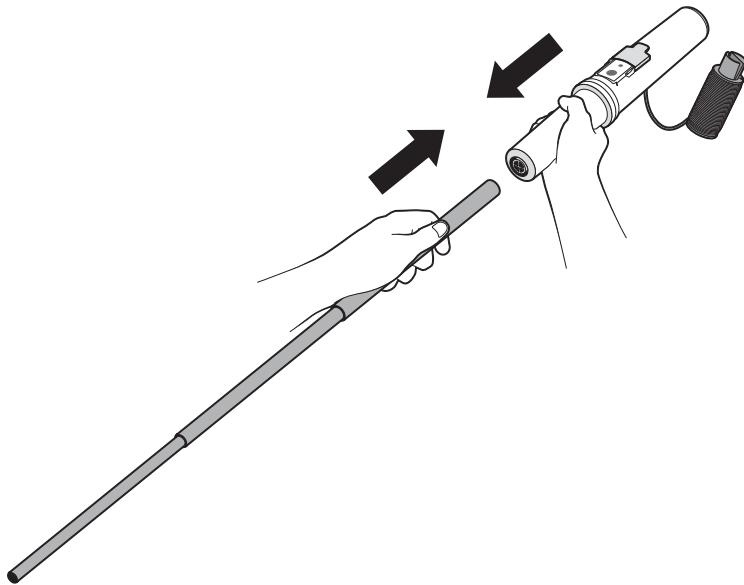

Figure 9 Attaching the telescopic mounting pole to the AIS SART

Deploying inside the liferaft canopy

Use the lanyard to tie the AIS SART to the highest point inside the liferaft canopy. The base of the AIS-SART should be 1 metre above sea level when deployed as shown in Figure 10.

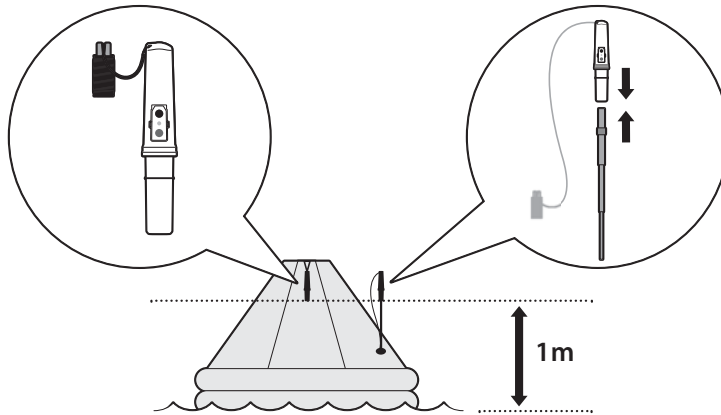

Figure 10 AIS SART deployment height

4.3 Deactivating the AIS SART

If the AIS SART is activated accidentally it can be deactivated by pressing and holding the test button for three seconds. The status indicator will turn off when the AIS SART is deactivated.

4.4 Testing the AIS SART

The AIS SART should be tested annually to confirm correct operation. In order to maximise the available battery capacity it is not recommended to test the AIS SART more frequently. Carry out the following steps to test the AIS SART:

1. Remove the AIS SART from the bracket or bag and move to an outdoor location with a clear view of the sky. Do not hold the AIS SART in the location marked over the internal GPS antenna.

2. Press and hold the 'Test' button for three seconds until the indicator starts flashing. The test is now active and the AIS SART will attempt to obtain a GPS position fix for five minutes.
3. The outcome of the test is indicated as shown in Figure 11. During the test AIS messages are transmitted and will be received by all nearby vessels. Refer to section 4.5 for further information on display of AIS SART position and messages on other equipment.
4. If a pass is not indicated by the end of the test period then the AIS SART should be relocated and the test repeated.
5. If battery expiry is indicated please contact your dealer to arrange for battery replacement. Section 5 provides further details on battery replacement.

The AIS SART test can be cancelled at any time by pressing and holding the 'Test' button for three seconds. The indicator will extinguish when the test has been cancelled.

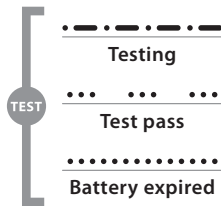

Figure 11 Status indicator in test mode

4.5 Display of AIS SART messages on other equipment

The AIS SART transmits both AIS position report and safety text messages when in active or test mode.

In active mode the text messages contain the text "SART ACTIVE" whilst in test mode the text messages contain the text "SART TEST".

Display on Class A AIS transceiver

The display of an AIS SART on Class A AIS transceivers is dependent on the age of the Class A transceiver and / or the equipment standard it complies with.

- Older Class A transceivers will display an AIS SART (in either active or test mode) as a vessel with MMSI matching the unique identifier of the AIS SART. A safety related text message "SART ACTIVE" will also be displayed.
- Class A transceivers conforming to the most recent standards will display an active AIS SART at the top of the vessel list and also output an alarm and safety related text message "SART ACTIVE". Test messages from AIS SART devices will not be displayed unless the AIS SART test feature is specifically enabled in the Class A equipment. Please refer to the Class A AIS transceiver documentation for further information.

Reception by Class B AIS transceiver

Class B AIS equipment is capable of receiving AIS SART position reports and text messages in both active and test modes. If the Class B AIS transceiver incorporates a display, a safety related message "SART ACTIVE" will be shown. However, display of the position of the AIS SART is dependent on connection to an external chart plotter or ECS. Please refer to documentation for the connected chart plotter or ECS for further information on display of AIS SART position reports and text messages.

Reception by AIS receiver

In most cases AIS receivers will be capable of receiving AIS SART position reports and text messages in both active and test modes. However, as AIS receivers are not subject to certification against an international AIS standard, reception cannot be guaranteed.

Display of the position of the AIS SART is dependent on connection to an external chart plotter or ECS. Please refer to documentation for the connected chart plotter or ECS for further information on display of AIS SART position reports and text messages.

Display on ECS / ECDIS

The display of an AIS SART on ECS / ECDIS equipment is dependent on the age of the equipment and the standard it complies with.

- Older ECS / ECDIS equipment will display an AIS SART (in either active or test mode) as a vessel with MMSI matching the unique identifier of the AIS SART. A safety related text message "SART ACTIVE" will also be displayed.
- ECS / ECDIS equipment conforming to the most recent standards will display an active AIS SART in red with the symbol shown in Figure 12. A safety related text message "SART ACTIVE" will also be displayed. It may be necessary to specifically enable display of AIS SART test messages in this equipment.



Figure 12 ECDIS symbol for AIS SART (ECDIS conforming to latest standards)

5 Battery information

The AIS SART contains a Lithium metal battery pack with a five year storage life. The battery expiry date is marked on the product information label on the rear of the AIS SART.

5.1 Battery replacement

The battery must be replaced before the expiry date. Replacement is vital to ensure that the battery has sufficient capacity to operate the AIS SART for the required 96 hours in an emergency situation. The battery must be replaced by an authorised dealer and is not user replaceable. Any unauthorized attempt to replace the battery will invalidate any warranty provided with the AIS SART and may also result in the AIS SART failing to operate in an emergency situation.

When the battery expiry date has passed the AIS SART will indicate battery expiry when tested (see section 4.4). Your dealer has access to the tools required to reset the expiry date and remove this indication.

5.2 Transport

The battery contained in the AIS SART is approved for carriage on passenger aircraft in hand baggage. However, it is recommended that the AIS SART is declared at check in.

The lithium content of the AIS SART batteries is sufficiently low for the device to fall under the 'not restricted' category for air cargo. To meet this requirement the AIS SART must be packaged and handled according to the IATA Dangerous Goods Regulations (53rd Edition, 2012), PI 970. Individual carriers may have additional requirements.

5.3 Disposal

The battery must be disposed of according to local regulations for the disposal of used batteries. Do not place in household or commercial waste.

6 Troubleshooting

Issue	Possible cause and remedy
The AIS SART does not pass the self test	<ul style="list-style-type: none"> • A successful self test is reliant on the AIS SART being able to obtain a GPS position fix. Please ensure that the AIS SART is outdoors and has a clear, unobstructed view of the sky overhead. Re-test the AIS SART. • The battery is depleted; please contact your dealer to arrange for replacement.
AIS SART test messages are not displayed on other equipment	<ul style="list-style-type: none"> • Please refer to section 4.5 for further information on the display of AIS SART position reports and text messages on other equipment. • Check that the display equipment is configured to display test messages from AIS SART. • Note that the AIS SART may be displayed as a vessel on some equipment. Check for display of a vessel with MMSI matching the unique identifier of the AIS SART. • Ensure that the AIS SART is not located near any large metallic structures that may affect the VHF transmissions.
Battery expiry is indicated during self test	<ul style="list-style-type: none"> • Please contact your dealer to arrange for service and battery replacement.
The status indicator does not illuminate or flash when the test button is pressed	<ul style="list-style-type: none"> • The battery is depleted; please contact your dealer to arrange for replacement.

7 Specification

Parameter	Value
Dimensions (AIS SART only)	384mm x 68mm (max. diameter)
Dimensions (Max. stowed in bracket)	100 x 100 x 384mm (L x W x H)
Weight (AIS SART only)	330g
Weight (stowed in bracket)	650g
Operating temperature range	-20°C to +55°C
Storage temperature range	-30°C to +70°C
Water ingress protection	IPx6 and IPx8
Compass safe distance	0.2m for 0.3° deviation
Operating life when active	96 hours
AIS transmitter frequency	161.975MHz (AIS1) and 162.025MHz (AIS2)
AIS transmitter power output	min. 1W EIRP
Battery	1500mAh Lithium metal, 5 year shelf life.
GPS receiver	48 channel with typical time to first fix of 35 seconds
Relevant technical standards	AIS SART - IEC61097-14 AIS and Radio - ITU-R M.1371-4 GPS - IEC61108-1 Environmental - IEC60945 (portable category) IMO MSC.246(83)